

# HWP-150-EXT FIREWOOD PROCESSOR



205 COLLEGE STREET  
PINE RIVER, MN 56474

218-587-2065

[WWW.HALVERSONWOODPRODUCTS.COM](http://WWW.HALVERSONWOODPRODUCTS.COM)



***Turning your skid steer  
into a wood  
processing monster!***

## **HWP-150-EXT FIREWOOD PROCESSOR**

**CONGRATULATIONS** on the purchase of a HWP-150-EXT Firewood Processor. This machine is designed and constructed to give you many years of hassle-free operation. Please be sure to read and understand the Operation / Safety Manual.

### **Skid Steer Requirements**

The HWP-150-EXT Firewood Processor is designed to operate with a standard auxiliary hydraulic flow of 15-20 gallons per minute (GPM). Flows of less than 15.5 GPM will result in reduced performance and lower productivity. Flow over 20 GPM will exceed the motor capabilities and cause premature failure. If your skid steer generates flows greater than 20 GPM, you will want to run it at reduced throttle setting to ensure the output DOES NOT EXCEED 20 GPM.

### **DO NOT RUN MACHINE ON HIGH FLOW!!!!**

**NOTE: Do NOT run the  
machine without a case drain.  
It will cause damage to the motor.**

The processor is designed to operate with hydraulic pressures of 2850 to 3000 PSI for optimum saw and splitter performance. Reduction in performance and productivity will result from pressures under 2850 PSI. It is important that the hydraulic pressure **DOES NOT EXCEED 3000 PSI!**

The HWP-150-EXT incorporated a valve body which has a maximum pressure of 3000 PSI and the valve body could fail if operated at higher pressures.

In addition to standard pressure and return lines, the HWP-150-EXT requires a low pressure case drain line. The chain saw motor has a small amount of internal leakage to provide lubrication to the motor's internal moving parts. The leakage collects in a cavity behind the motor's shaft seal. If the oil has no place to go, it can generate enough pressure to damage the shaft seal. It is not acceptable to "tee" the case drain line into the Skid Steer's normal return line (tank line). Oil in the return line passes through the return filter going to the hydraulic reservoir which creates back pressure in the return line that is greater than the saw motor seal can handle. The low pressure case drain line must connect directly to the reservoir with no restrictions.

# HWP-150 SPECIFICATIONS

Length .....	Travel Configuration: 121" Working Configuration: 143"
Width .....	58"
Height .....	57"
Weight .....	1905 lbs.
Hydraulic Requirements .....	Flow: 15.5 gpm Pressure: 2850 psi -3000 Connections: 1-pressure, 1- return and 1-case drain
Control System.....	Solenoid operated valves mounted on the processor. The valves are controlled by means of an optional detachable harness with two pods each containing 3 push buttons and a third lead which plugs into the 12 volt power port.
Adaptor Harness .....	You can run the processor using the provided 14 pin attachment harness, if you have a 14 pin connector, mounted by your quick couplers, and have 6 powered buttons on your controls. Otherwise, you will need to purchase one of the Halverson Main Cab Button Harnesses.
Max Log Diameter .....	22"
Max Log Length .....	12'
Min Log Length .....	6'
Firewood Cut Lengths.....	up to 33"
Saw Chain.....	.404 pitch, 80 gauge, 18HX Harvester Series
Saw Bar.....	length: 31" (80cm) Harvester Series
Saw Motor .....	Piston Pump Bent Axis Motor
Saw Oiler .....	Automatic 2 quart oil tank
Max Saw Cut.....	22"
Splitter Cylinder .....	4" Bore x 36" Stroke
Splitter Force.....	36,138 lbs. @ 2850 PSI
Splitting Wedge.....	4-way adjustable standard or 6-way adjustable optional
In-feed.....	Sliding trough carries log to wedge
Mounting .....	Universal Quick Attach SAE Spec J2513
Adjustable Splitter RAM.....	8" stroke

**NOTE:** Specifications are subject to change without prior notice. Please verify actual specifications prior to purchase. PROTECTED BY US PATENT #7,669,618 B1



## DIAGRAM OF HWP-150-EXT MAIN PARTS

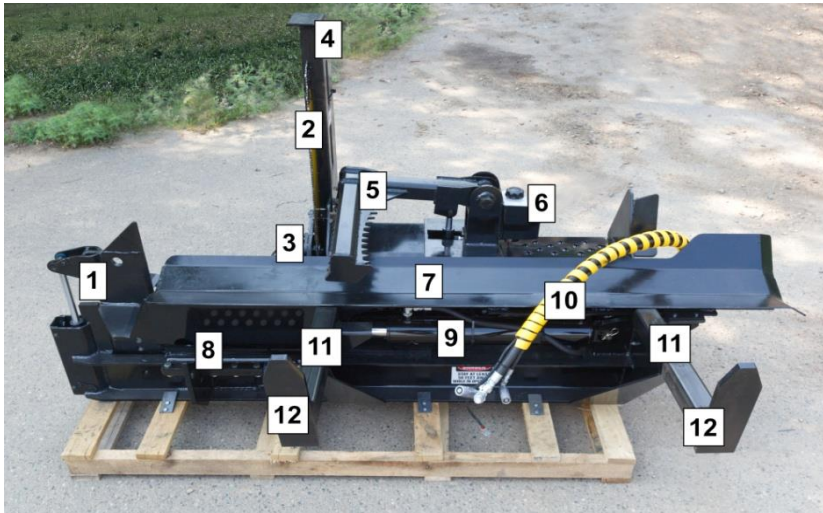

- 1- 4-WAY HYDRAULIC SPLITTER HEAD
- 2-CHAIN SAW
- 3-CHAIN SAW MOTOR
- 4-CHAIN SAW GUARD
- 5-GRAB ARM
- 6-OIL CONTAINER
- 7-TABLE
- 8-TABLE TROUGH
- 9-SPLITTER CYLINDER
- 10-LEAD HOSES
- 11-LEG
- 12-FEET

## DIAGRAM OF HWP-150-EXT VALVE BODY

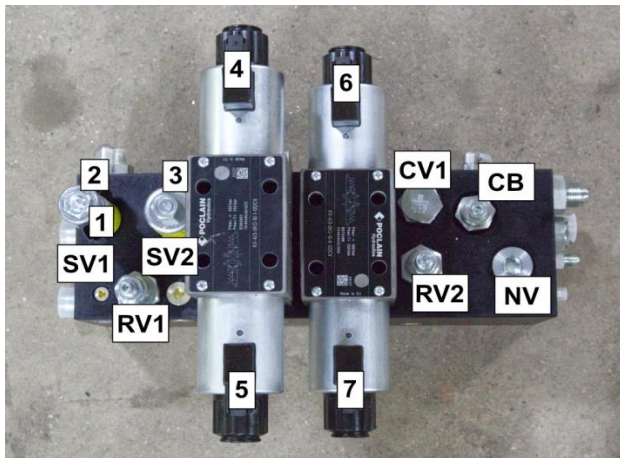

### VALVES

- SV1- GRAB ARM UP & DOWN
- SV2- UNLOADER DOWN
- RV1- MAIN PRESSURE RELIEF
- RV2- SAW UP PRESSURE
- NV- PLUG
- CV1- CAP
- CB- FLOAT VALVE

### WIRE LOCATION

- 1- GRAB ARM UP
- 2- GRAB ARM DOWN
- 3- UNLOADER
- 4- TABLE BACK
- 5- TABLE FORWARD
- 6- SAW UP
- 7- SAW DOWN

## HWP-150-EXT VALVE BODY

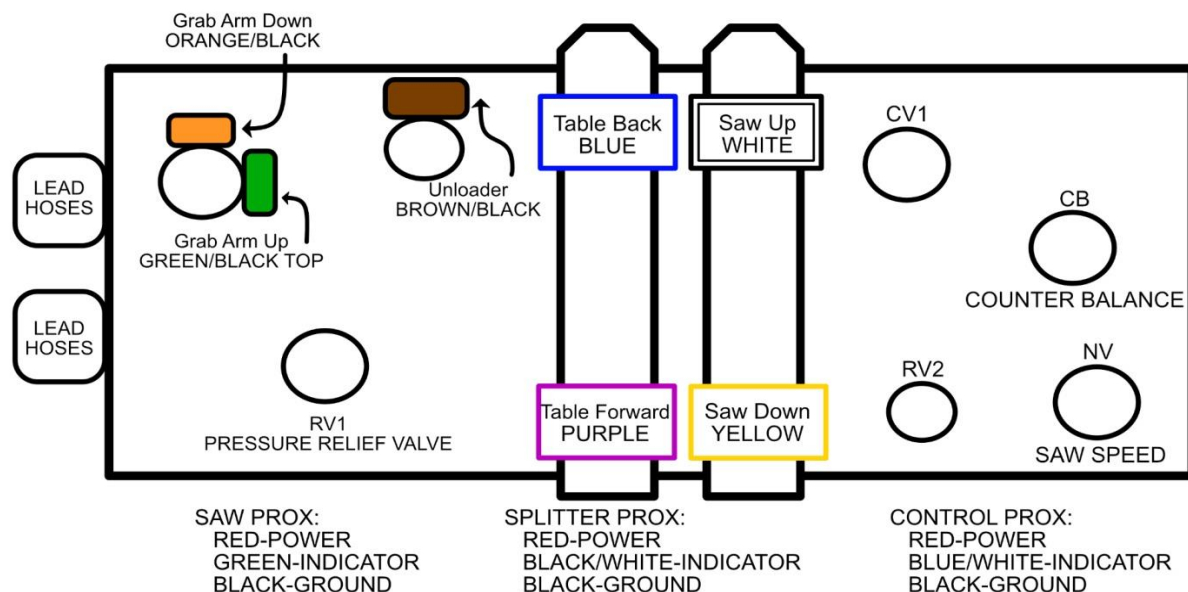

## GENERAL SAFETY

### LABELS:

Your HWP-150-EXT Firewood Processor carries prominent labels as reminders for its proper and safe use. Shown below are copies of all the labels that appear on the equipment. Take a moment to study them and make note of their location on your processor before you operate the unit. Replace damaged or missing labels immediately.



### FIREWOOD PROCESSOR CAPABILITITES AND LIMITS:

- Use to process logs, do not use for other purposes (this will void warranty)
- Process only wood that is within recommended size limits
- Process one log at a time.
- Do not modify the processor except as noted in this manual (this will void warranty)
- Make sure all skid steer safety devices are in working order
- Before exiting cab, shut down the engine on the skid steer
- When entering or exiting cab, maintain 3 points of contact.
- Before performing any maintenance or inspection, shut down the skid steer engine

## SAFETY (continued)

### OPERATOR REQUIREMENTS:

- Operators must be adults and familiar with the operation of the skid steer and HWP-150-EXT.
- Never operate while impaired.

### GENERAL SAFE OPERATING PRACTICES:

- Keep all bystanders at least 50 feet away while operating processor. Do not allow bystanders directly in front of or directly behind processor.
- Operate only from within enclosed cab.
- Keep hands and feet away from processor's moving parts. **WARNING!!** Never load wood into OR remove wood from the processor or splitter by hand.

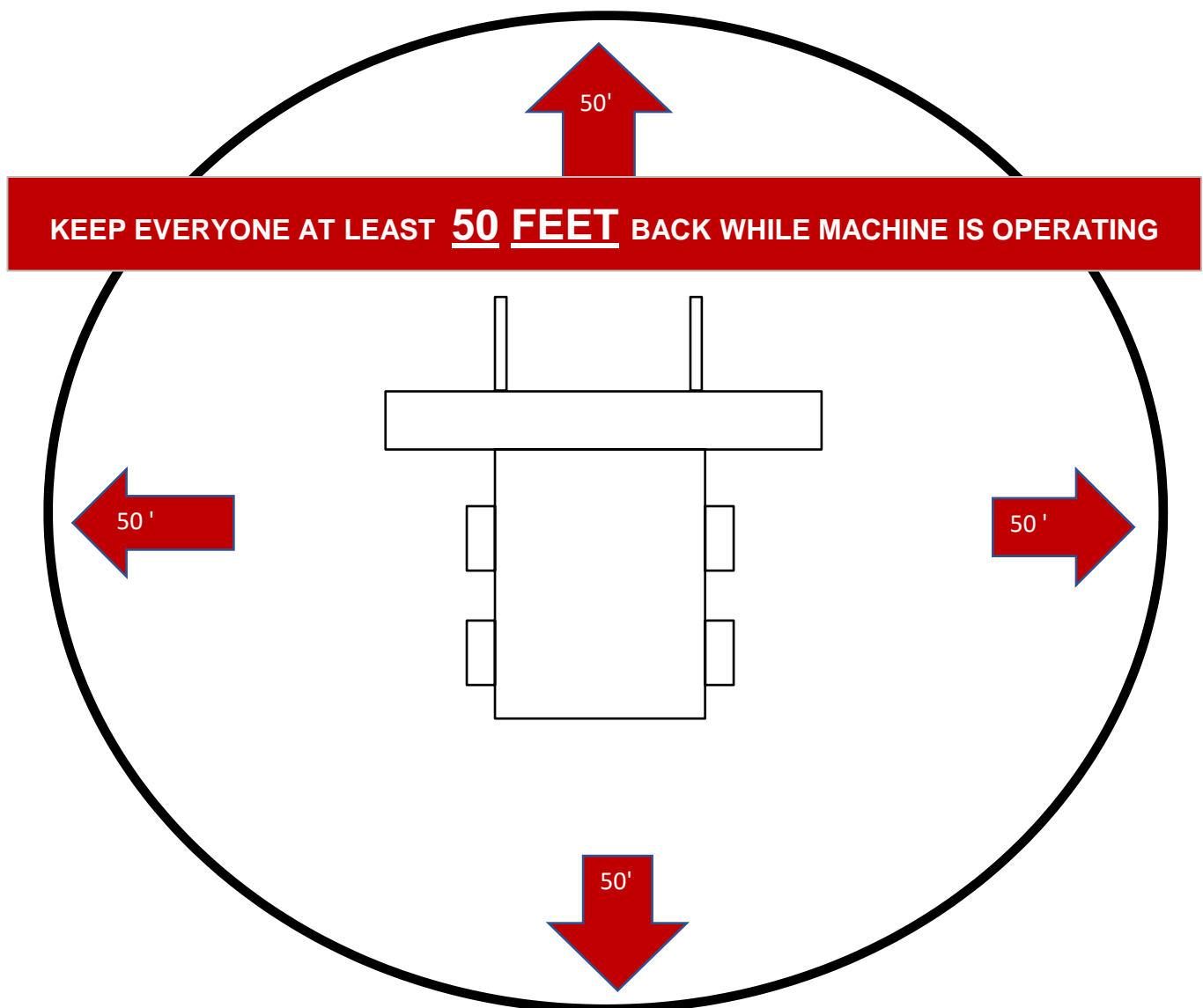

## General Safety-continued

### Chain Shot

#### What is chain shot?

Chain shot is the high velocity separation and ejection of a piece or pieces of cutting chain from the end of a broken chain in mechanized timber harvesting. Chain shot exposes both machine operators and bystanders to a risk of serious injury or death. Chain shot typically occurs near the drive end of the cutting system but can also come from the bar tip area.

Industry research indicates an average of 1 in 50 broken chains had parts missing that may have been the result of a chain shot event.

#### How does chain shot occur?

A chain shot consists of two breaks in a chain.

First, the loop of chain breaks and forms two ends. One end moves past the drive sprocket or bar nose and is rapidly accelerated due to a whip-like motion of the chain end.

The “whip action” causes the second break releasing small parts at supersonic speed.

Chain shot can cause chain parts to be thrown in many directions, especially those along the plane of the saw bar.

#### What does a typical chain shot piece look like?

The most dangerous chain shot parts consist of one to four parts as shown:



#### How can an operator reduce the risk of chain shot?

- Operators and bystanders must never be in the plane of the bar when the chain is in motion on the bar.
- Appropriate windshield material must be installed.
- Chain speed must be 8000 ft/min (40m/s) or less for .404 pitch Oregon® Harvester chain and 7000 ft/min (35m/s) or less for 3/4 pitch Oregon® Harvester chain.
- A chain shot guard should be installed near the drive sprocket.
- Chains should be inspected frequently and damaged or cracked chains removed from service.
- Always use new Oregon® parts when repairing Oregon® chains.
- Industry groups recommend that chains should be discarded after the second break.
- Remove all dull and/or worn chains from service.
- Always sharpen Oregon® chains to Oregon® factory specifications.
- Maintain proper bar and chain lubrication.
- Maintain proper chain tension.
- Replace the drive sprocket when it has visible signs of wear.

For additional information see the *Oregon® Mechanical Timber Harvesting Handbook*.



## Installation

### Fitting the Processor to the Skid Steer

- ✓ Engage the upper portion of the skid steer's quick-attach mount, and then rotate the mount into position against the processor's main mounting plate.
- ✓ Lock the pins or wedges to secure the processor to the skid steer mount. Make sure the locks, pins or wedges, are fully engaged into the slots on the processor mount. **WARNING!** If you need to raise the boom to check that the locks are engaged, observe from a safe distance. **DO NOT** allow anyone underneath a suspended processor.
- ✓ Rotate the processor fully forward until the feet on the processor's forks rest flat on the ground. If the skid steer's bucket dump angle will not allow the feet to rest flat, contact your dealer.
- ✓ **SLOWLY** rotate the processor fully back to ensure it does not come into contact with the skid steer or its boom houses and wiring.
- ✓ Lower the processor and detach from the quick-attach mount to allow easier access to the skid steer cab while installing the wiring.

### Installing Wiring Harness – Optional

The wiring control system for the processor consists of wires and a harness assembly with two three button control pads, power lead and ground lead fitted with a fused power port plug along with 22 feet of cable. (See page 14 for button diagram)

**NOTE:** When disconnecting processor from the skid steer, **DO NOT** pull on the wires. You may pull the wires out of the quick connect ends.

This assembly must be routed from the cab to the front of the skid steer's left boom. The push button mounts are labeled Left and Right. These should be attached to the front side of the skid steer's joy sticks with a 3/16" wire or cable ties passed through the holes provided in the mounts. Each mount should be placed with its cable running to the inside, toward the seat and the buttons should face the door. Wire or Cable ties should be used to secure the wires to the loaders joysticks to prevent rubbing and flexing at the point where the wires enter the mount. It is recommended that you avoid flexing the cables at any point along the length of the wires. Gradual large radius bends are preferred.

**NOTE:** Skid Steer Legs are not designed to bust frozen wood off the ground. Attempting to break frozen pieces loose may result in damage to the structure of the Firewood Processor

The 22 foot cable should be routed to the front of the boom just behind the quick coupler area. In most cases the cable is best routed by raising the skid steer cab. When installing the cable, avoid any sharp edges or corners which may damage it. Find a protected location for the 8 pin plastic plug behind the quick couplers to protect it from damage when other attachments are being used on the skid steer. Route the cable so it will not be damaged as the boom is moved through the full range of motion. This typically means routing the cable as close to the boom pivot pins as possible. We recommend large wire cable ties for this.

Plug the fused plug into the power port. If the skid steer does not have a power port, one must be installed to accommodate the fused power plug provided.

**NOTE:** In extreme wet conditions dry your electrical plug connection out before operating, it may cause issues if plug is not dried out before using.



## Installation, continued

### Connecting the Processor to the Skid Steer

With the wiring completed, the firewood processor can be reattached and the cable and hydraulic connections can be made. Connect the case drain hose to the case drain quick coupler on the skid steer, then the pressure line (“P”) and the tank/return line (“T”). **The “P” hose must be fed with oil from the skid steer loaders pressure connection. The “T” hose must be connected with the skid steer’s tank or return circuit. If you are not sure of these connections, please verify them before you connect the processor to the skid steer’s hydraulic quick couplers.**

**NOTE: Some machines have a bidirectional valve controlling the output of oil to the quick couplers. This valve is typically controlled by a switch in the cab. If your loader is so equipped, you must establish which position the switch must be in to result in pump flow out of a given coupler. Always be sure to select the proper switch position when coupling up to the firewood processor.**

**\*\*FAILURE TO FOLLOW THIS PROCEDURE WILL RESULT IN THE ELIMINATION OF THE PROCESSOR’S RELIEF VALVE PROTECTION AND POSSIBLE DAMAGE TO THE PROCESSOR’S HYDRAULIC COMPONENTS.**

If you are in doubt about the proper connections to the “P” and “T” hoses, perform the following test:

- Start the engine and leave the throttle at low idle
- Turn on the electrical power to the processor (plug the cable into the socket and watch for the yellow indicator light on the saw proximity switch)
- Turn on the skid steer’s auxiliary hydraulic system
- Momentarily press the middle GRAB ARM button (one down on the left control pad) and the GRAB arm should rise. IF NOT, DO NOT OPERATE ANY OTHER FUNCTION ON THE PROCESSOR. The hose assignments are wrong. Either flip the skid steer’s bidirectional switch or swap the hoses on the quick couplers.

Before putting the processor into service, carefully check the routing of the cables and hoses leading to the processor to ensure that they don’t get damaged, stretched or hit as the processor is rolled forward and back.

## Adjustment and Control Functions

**SAW OILER:** To increase the oiler pump output, turn the adjusting stem out (counter clockwise). To decrease the amount of bar oil, turn the stem in (clockwise).



Loosen/tighten jam nut

### NOTES:

- Splitter Head Bolts should be re-torqued after 20 minutes of use.
- It is common to have excess oil dripping off the saw bar.
- Oiler may need to be adjusted. You should see a mist of oil when saw button pushed.
- Loosen jam nut then adjust bottom brass screw in for less oil or out for more oil, tighten jam nut.

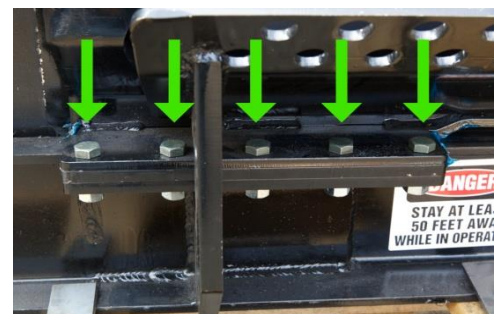

Splitter Head Bolts  
Front/Back

218-587-2065

[www.halversonwoodproducts.com](http://www.halversonwoodproducts.com)

## Adjustment and Control Functions, continued

### **CLEANING:**

Keep the splitter area, valve compartment and splitting table free of debris. Inspect the skid steer's radiator and oil cooler on a regular basis and look for build-up of saw dust and other debris. Pressure wash the radiator and oil cooler regularly to prevent overheating and damaging the skid steer and processor components.

### **LUBRICATION INTERVALS: DAILY:**

- Grab arm pivot points
- Pin connectors saw arm bearings
- Saw cylinder pivot points
- Adjustable head cylinder pivot points

### **CHAINSAW:**

Table must be all the way to the left. To engage the saw, press the second button down on the right hand control pad. To raise the saw, release the button.

### **SAW CHAIN TENSIONING:**

Maintain proper chain tension by adjusting the saw bar tension screw. If the chain runs too loose, it can hit the inside of the guard and become dull and cause premature damage to the saw chain. The chain is properly tensioned when you can pull the tie straps 1/8" from the surface of the bar's rails in the center of the bar. Do not tighten if it is hot as it will shrink when it cools and will stress the chain and the bar's sprocket nose.

Regularly monitor the bar oil flow to ensure the chain is being lubricated sufficiently but not excessively. Use only quality bar and chain oil.

Regularly monitor the condition of the chain's cutters and sharpen as required. Failure to do so will result in reduced saw performance.

### **SPLITTER /TABLE:**

Press the TABLE FORWARD button (the top button on the right hand control pad) to extend the splitter cylinder attached to the table. This will simultaneously split the wood.

### **HOME POSITION FOR SAW & TABLE**

- The home position for the saw is all the way back inside the guard.
- The home position for the table is all the way back, to the left.
- The travel position for the table is all way out, to the right.

### **ADAPTOR 14 PIN CONNECTOR**

You will need 6 electronic buttons that sends 12 volts to the 14 pin connector. You will also need constant power and ground on the 14 pin connector for a total of 8 pins. If you do not have enough functions you will need a Halverson Main Cab Harness Kit.

The HWP-150 will work on a Bobcat 7-pin if skid steer has pilot controls (no foot pedals).

## Adjustment and Control Functions, continued

### MEASURING DEVICE

**STEP 1:** Locate the adjuster plate for the measuring device.



**STEP 2:** Loosen the two 5/16 bolts with 1/2" wrench

**STEP 3:** Adjust the plate according to what you want your length of the wood to stop at.

**STEP 4:** Tighten the two 5/16" bolts on the adjuster plate.

### DISABLE THE MEASURING DEVICE

To disable the measuring device, take off the adjuster plate with the two 5/16" bolts. This will disable the measuring device so it won't stop on the table back.

The factory setting on the measuring device is about 16"-18".

### HOW THE MEASURING DEVICE WORKS

When you have the measuring device hooked up, after you split your log on the table back, it will stop at the desired length.

Press and hold the Grab Arm Down button to pinch the log, once you let go of the Grab Arm Down button, the splitter will automatically return to the home position.

The processor is ready for the next cut.

## Precautions

The chainsaw is equipped with an auto return features. When the control button is released, the saw will automatically return to its home position. **BE WARE OF THIS FEATURE WHEN WORKING AROUND THE PROCESSOR.**

**SHUT OFF ENGINE WHENEVER PERFORMING CLEAN-OUT OR SERVICE WORK.** Attempting to go around or defeat these auto return features to gain access to an area of the machine can result in serious injury or death.

Make sure the processor is sitting completely on the ground before dismounting the machine.

Ensure all personnel are safely out of the way when operating the firewood processor and make sure that no one is in line with the chain saw.

**THE CHAIN SHOT AREA.** SERIOUS INJURIES AND DEATH HAVE BEEN REPORTED WHEN HIGH SPEED CHAIN SAW COMPONENTS SEPARATE AND BECOME HIGH SPEED PROJECTILES.

Know where all personnel are around the skid steer at all times. The splitting function often produces dangerous flying debris and wood particles. **KEEP PEOPLE AT LEAST 50 FEET AWAY FROM THE MACHINE WHILE RUNNING.**

*When Processor is not in use, disconnect power cord or it could drain your battery and shorten the life of your electrical components.*

## Replacing the Chain

**Oregon Harvester Chain - Part #18HX093E – (.404 pitch-93DL-.080” / 2.0mm)**

**STEP ONE:** Position the log table in the home position. From the cab this would be all the way to the left.

**STEP TWO:** Turn off oil

**STEP THREE:** Hold Saw button down, temporarily run oil to machine while bar goes down.

**STEP FOUR:** While holding the saw down button, lower bar to  $\frac{3}{4}$  of the way down. Stop oil flow.

**STEP FIVE: SHUT SKID STEER MOTOR OFF!!**

**STEP SIX:** Loosen saw clamp bolts. See picture.

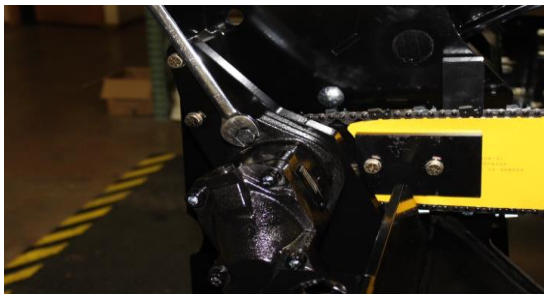



## Replacing the Chain, continued

**STEP EIGHT:** Loosen adjustment screw on front side of saw bar

**STEP NINE:** Remove Chain

**MOUNTING NEW CHAIN:**

Reverse steps to mount new chain

**NOTE:**

Chain requires a 7/32" file to sharpen.



## Optional Cab Harness Kit Control Diagram HWP-150-EXT

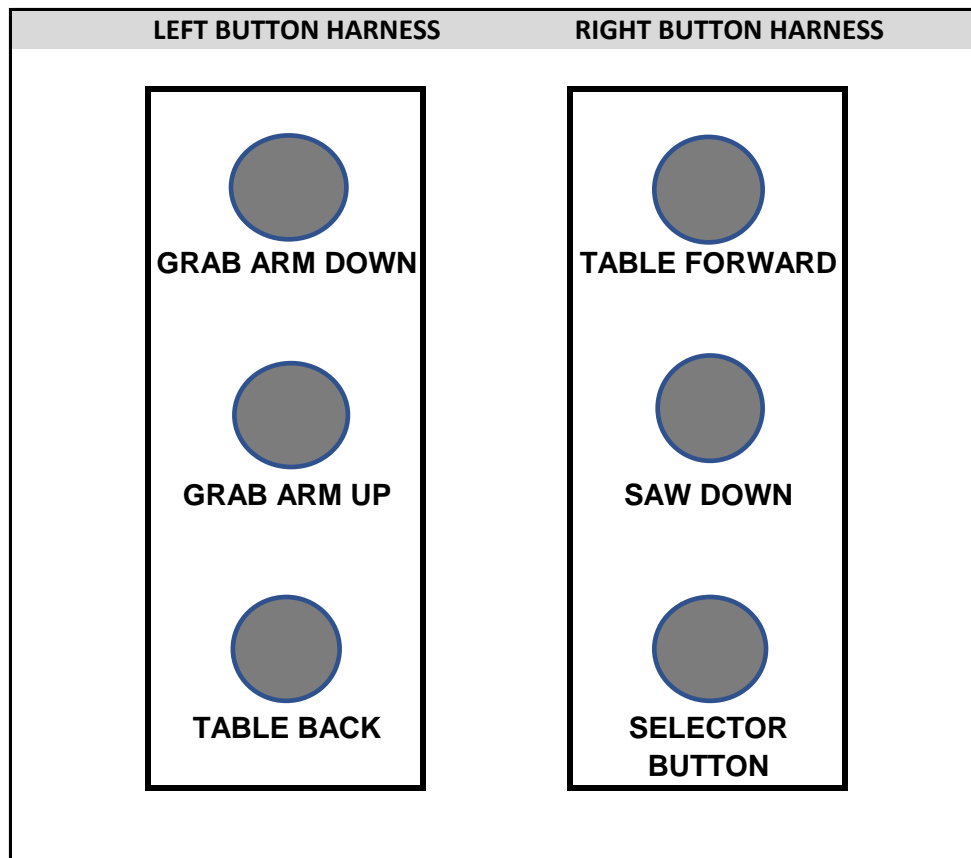

## Operating Sequence

- 1) Roll processor forward until the feet at the end of the legs are parallel to the ground.
- 2) Drive to the log pile and place the feet under a log.
- 3) Roll the processor back to pick up the log and allow it to roll down the legs onto the table.
- 4) Press and hold the TABLE FORWARD button to extend the splitting cylinder and table carrying the log to the splitter head.
- 5) Press TABLE BACK button, enabling the table to retract to the measuring device, where it will stop automatically.
- 6) Press the GRAB ARM DOWN button to hold the log in position.
- 7) Once you let go of the GRAB ARM DOWN button, the table will automatically return to the home position. (all the way to the left)
- 8) Press and hold the SAW DOWN button to cut a piece from the log. As the cut is completed, the log will fall into the splitter bin.
- 9) Release the SAW DOWN button to allow the saw to retract to its home position.
- 10) Press the GRAB ARM UP button to release the remaining log.
- 11) To adjust the height of the splitter, press and hold the SELECTOR BUTTON (lower right button) use grab arm buttons to raise or lower splitter head.
- 12) Press the TABLE FORWARD button to extend the table. This action splits the wood while delivering the remaining log to the splitter wedge for the next cut.

# Warranty

## Warranty Duration

Unless otherwise provided in writing by Halverson Wood Products Inc., Halverson Wood Products makes the following warranty to the first retail purchaser of each HWP-150-EXT attachment:

One (1) year from the date of delivery to the first retail purchaser.

## Warranty Coverage

This warranty applies to the HWP-150-EXT Skid Steer attachment manufactured by Halverson Wood Products, Inc. All parts and components of the HWP-150-EXT which, delivered to the original purchaser, are found to be defective in materials and/or workmanship, will be repaired or replaced as Halverson Wood Products Inc. elects without charge for parts or repair labor if such defect appears within the warranty period as measured from the date of delivery to the first retail purchaser and if the delivery is reported within 30 days of delivery via mail or email:

Halverson Wood Products Inc.  
205 College Street  
Pine River MN, 56474  
218-587-2065

E-mail: [halversonwoodproducts@halversonwp.com](mailto:halversonwoodproducts@halversonwp.com)

## Obtaining Warranty Service

Warranty repair work must be pre-authorized by Halverson Wood Products Inc, call 218-587-2065 for authorization. Warranty service must be requested of the nearest authorized Halverson Wood Products dealer or directly from the factory before the expiration of the warranty. Halverson Wood Products Inc. or authorized repairmen will only use new or re-manufactured parts or components furnished or approved by Halverson Wood Products Inc. At the time of requesting warranty service, the purchaser must be prepared to present evidence of the date of delivery of the HWP-150-EXT.

## Warranty Exclusions

Halverson Wood Products obligations shall not apply to any part or component not manufactured, furnished or installed by Halverson Wood Products nor failures caused by such items. Specifically excluded are failures of and damage to any vehicle or other piece of equipment either rubber tired or tracked upon which the HWP-150-EXT is attached and any damage to the HWP-150-EXT caused by failure on a vehicle or other piece of equipment upon which the firewood processor is attached.

## Purchaser's Responsibilities

- The cost of normal maintenance and depreciation.
- Consequences of negligence, misuse or accident involving the HWP-150-EXT.
- Consequences of service performed by someone other than a party authorized to perform warranty service, if such service, in Halverson Wood Products judgment, has adversely affected the performance or reliability of the processor.
- Consequences of any modification or alteration of the machine or the attachment not approved by Halverson Wood Products Inc. These include, but are not limited to hydraulic pressure settings, contamination of the hydraulic system, changes to the main frame, saw pivot and wedge mounts.
- The effects of hydraulic system neglect as manifested in hydraulic motor pitting, scoring, erosion, valve spool sticking and other internal component caused by cavitations, contamination, high oil temperatures and excessive hydraulic pressure.
- Consequences of excessive system back pressure within the machine to which the HWP-150-EXT is attached. Excessive back pressure can cause degraded performance from the processor.
- Any premium for overtime labor requested by the purchaser.
- Costs of transporting the processor to and from the location at which the warranty service is performed.
- Cost incurred in gaining access to the machines or attachments. Overcoming physical barriers such as walls, fences, ditches, streams or similar structures impeding access to the HWP-150-EXT or rental of cranes or similar construction of ramps or lifts.
- Incidental travel costs including tolls, meals, lodging and similar expense.

## Warranty, continued

### Purchaser's Responsibility, cont.

- Services performed by a party other than authorized Halverson Wood Products Inc. Personnel.
- Charges by dealers for initial machine set up, installation, start up and inspection deemed unnecessary by Halverson Wood Products Inc. when operation and maintenance instructions supplied with the HWP-150-EXT are followed.
- Cost of interpreting or translating service.

### Replacement Parts Warranty

New Halverson Wood Products Inc. parts installed during firewood processor warranty service are warranted for the remaining warranty period of the processor. A new processor replacing a failed processor is warranted for the remaining period of the original processor.

### No Representation or Implied Warranty

Where permitted by law, neither Halverson Wood Products Inc. nor any company affiliated with it makes any guaranties, warranties, conditions, representations or promises express or implied, oral or written, as to the non-occurrence of any defect or the quality of performance of its machines or attachments other than those set forth in the document and DOES NOT MAKE ANY IMPLIED WARRANTY OR CONDITIONS OF MERCHANTABILITY OR FITNESS otherwise provided in the Uniform Commercial Code or required by any Sale of Goods Act or any other statute. This exclusion includes fundamental terms. In no event will a Halverson Wood Products Inc. authorized dealer or a Halverson Wood Products Inc. authorized service facility, or Halverson Wood Products Inc. or any company affiliated with Halverson Wood Products Inc., Be liable for incidental or consequential damages or injuries including, but not limited to, loss of profits, loss of firewood contracts, rental of substitute equipment or other commercial loss or damage suffered by the purchaser as a result of fundamental breaches of contract or breach of fundamental terms unless such damages are caused by the gross negligence or intentional acts of the foregoing parties.

### Remedy Limitations

The remedies set forth in this warranty are the purchaser's exclusive remedies in connection with the performance of or any breach of guaranty, condition, or warranty in respect of the Halverson Wood Products Inc. firewood processors. In the event that the above warranty fails to correct purchaser's performance problems caused by defects in workmanship and or materials, purchaser's exclusive remedy shall be limited to payment by Halverson Wood Products Inc. of actual damages in an amount not to exceed the cost of the HWP-150-EXT Firewood Processor.

### No Sellers Warranty

No person or entity other than Halverson Wood Products Inc. who sells the HWP-150-EXT firewood processor makes any guaranty or warranty of its own on any processor warranted by Halverson Wood Products Inc. unless it delivers to the purchaser a separate written guaranty certificate specifically guaranteeing the processor, in which case, Halverson Wood Products Inc. will have no obligation to the purchaser. Neither equipment distributors, equipment dealers, nor any other person or entity, has the authority to make a representation or promise on the behalf of Halverson Wood Products Inc. or to modify its terms in any way.

### Warranty Transfer

The remainder of the original warranty may be transferred to the subsequent owner of the HWP-150-EXT only by express written consent. Please report the transfer of ownership to Halverson Wood Products Inc. by phone at 218-587-2065 or by e-mail at [halversonwoodproducts@halversonwp.com](mailto:halversonwoodproducts@halversonwp.com).



## Trouble Shooting

### Problem

### Possible Cause

### Solution

#### Saw stalls when lowered:

RPM too Low.....	Rev the motor
Bar is not getting oil .....	Oiler will not oil
Too much Down Pressure.....	Adjusting Saw Feed Adjust CB clockwise

#### Oiler will not Oil:

Low Oil.....	Fill Oil
Hose to saw bar is kinked or cut .....	Staighthen or replace
Oiler is plugged.....	Disassemble and clean check valve

#### Nothing works when buttons are pushed:

Bad Fuse .....	Check fuses in power plug
Frayed Wire.....	Broken wire in power plug
Bad Ground.....	Check ground wire
Hydraulic flow direction is wrong .....	Reverse direction of flow
Not getting any oil to processor .....	Refer to skid steer manual

#### Saw does nothing when saw down button is pushed:

Proxy on splitter back .....	Needs adjusting
------------------------------	-----------------

#### Bar oil reservoir drains out overnight:

Check valve stuck open.....	Clean or replace check valve
Oil Delivery hose worn or broker .....	Replace

#### Saw comes down and chain is spinning but does not cut:

Chain dull .....	Sharpen Chain
Bar is rough on edge! .....	Replace Bar

#### Saw Caviates or bounces when cutting

Not enough down pressure.....	Adjust CB counter clockwise
Not getting enough oil flow to processor ...	Increase RPM

## ATTACHMENT HARNESS 14 PIN OUT PLACEMENTS

\*Suggested Pin Out-Please contact your skid steer dealer for specifics

<b>CAT Pre 2022</b>		
J	POWER	Red
B	GROUND	Black
C	SAW DOWN	Yellow
D	SPLITTER OUT	Purple
E	GRAB UP	Green
F	GRAB DOWN	Orange
A	SPLITTER BACK	Blue

<b>KUBOTA</b>		
K	POWER	Red
B	GROUND	Black
C	SAW DOWN	Yellow
D	SPLITTER OUT	Purple
F	GRAB UP	Green
E	GRAB DOWN	Orange
H	SPLITTER BACK	Blue

<b>CAT 2022 &amp; Newer</b>		
P	POWER	Red
J	SHIFT/WEDGE	Grey
B	SAW DOWN	Black
C	SPLITTER OUT	Yellow
D	GRAB UP	Purple
E	GRAB DOWN	Green
F	SPLITTER BACK	Orange
A	TABLE OPEN	Blue

<b>KUBOTA SVL</b>		
K	POWER	Red
B	GROUND	Black
C	SAW DOWN	Yellow
D	SHIFT/WEDGE	Grey
E	GRAB UP	Green
F	GRAB DOWN	Orange
G	SPLIT	Purple
H	TABLE OPEN	Blue

<b>BOBCAT</b>		
K	POWER	Red
B	GROUND	Black
H	SAW DOWN	Yellow
A	SPLITTER OUT	Purple
F	GRAB UP	Green
E	GRAB DOWN	Orange
D	SPLITTER BACK	Blue
G	SHIFT/WEDGE	Grey

<b>JCB-VOLVO</b>		
K	POWER	Red
B	GROUND	Black
H	SAW DOWN	Yellow
C	SPLITTER OUT	Purple
F	GRAB UP	Green
E	GRAB DOWN	Orange
D	SPLITTER BACK	Blue
G	SHIFT/WEDGE	Grey

<b>CASE</b>		
K	POWER	Red
B	GROUND	Black
G	SAW DOWN	Yellow
E	SPLITTER OUT	Purple
C	GRAB UP	Green
D	GRAB DOWN	Orange
F	SPLITTER BACK	Blue

<b>GEHL-MUSTANG</b>		
A	POWER	Red
B	GROUND	Black
G	SAW DOWN	Yellow
E	SPLITTER OUT	Purple
D	GRAB UP	Green
C	GRAB DOWN	Orange
F	SPLITTER BACK	Blue

<b>TEREX-ASV-TAKEUCHI</b>		
K	POWER	Red
B	GROUND	Black
J	SAW DOWN	Yellow
E	SPLITTER OUT	Purple
D	GRAB UP	Green
C	GRAB DOWN	Orange
F	SPLITTER BACK	Blue

<b>JOHN DEERE</b>		
H	POWER	Red
A	GROUND	Black
D	GRAB ARM UP	Green
G	SPLITTER OUT	Purple
F	GRAB UP	Blue
C	SPLITTER BACK	Yellow
E	GRAB ARM DOWN	Orange

<b>NEW HOLLAND</b>		
J	POWER	Red
B	GROUND	Black
CAT	SAW DOWN	Yellow
E	SPLITTER OUT	Purple
C	GRAB UP	Green
D	GRAB DOWN	Orange
F	SPLITTER BACK	Blue

<b>JOHN DEERE 2023 &amp; NEWER</b>		
K	POWER	Red
A	GROUND	Black
C	GRAB DOWN	Orange
G	GRAB UP	Green
D	TABLE OPEN	Blue
E	SPLIT	Purple
F	SAW DOWN	Yellow
H	SHIFT/WEDGE	Grey

<b>WACKER NEWSON</b>		
K	POWER	Red
B	GROUND	Black
C	GRAB DOWN	Orange
D	GRAB UP	Green
E	TABLE OPEN	Blue
F	TABLE SPLIT	Purple
G	SAW DOWN	Yellow
H	SHIFT/WEDGE	Grey





## Warranty & Manual Release Form

***By signing below, the Customer (Purchaser) acknowledges the following:***

I have received the HWP-150-EXT Operations/Safety Manual  
I have read and understand the HWP-150-EXT Operations/Safety Manual  
Halverson Wood Products Inc. accepts no responsibility for misuse of the HWP-150-EXT Firewood Processor.  
Any modifications to the HWP-150-EXT Firewood Processor not performed by authorized service technicians will void Warranty.

\_\_\_\_\_  
Signature

\_\_\_\_\_  
Date

### Warranty Registration

Model # HWP-150-EXT Firewood Processor

Date Purchased: \_\_\_\_\_

Serial Number: \_\_\_\_\_

Purchased By:

Name: \_\_\_\_\_

Company: \_\_\_\_\_  
(if applicable)

Address: \_\_\_\_\_

Phone: \_\_\_\_\_

Email: \_\_\_\_\_

*Please print information in area provided.*

*Refer to sales policy number 8 under authorized dealers.*

Return to:

**Halverson Wood Products Inc.  
199 College Street**

**218-587-2065**

**[www.halversonwoodproducts.com](http://www.halversonwoodproducts.com)**